

For your safety, please read the following before using.

- ① Do not use corrosive or flammable gas or liquid with this product.
- ② Please use within the rating pressure range. Do not apply pressure beyond recommended maximum withstand pressure, permanent damage to the pressure sensor may occur.
- ③ Do not drop, hit or allow excessive shock. Even if switch body appears undamaged, internal components may be broken and can cause malfunction.
- ④ Turn power off before connecting wiring. Wrong wiring or short circuit will damage and / or cause malfunction.
- ⑤ Do not use in environment containing steam or oil vapor.
- ⑥ This product is not explosion-proof rated. Do not use in atmosphere containing flammable or explosive gases.
- ⑦ Wiring for pressure sensor should avoid power source line and high voltage line. If use in the same circuit, noise may cause malfunction.
- ⑧ Sensors at end-of-life must be disposed of in accordance with E-Waste regulations of the country/region, NOT disposed of with regular garbage.

A SPECIFICATIONS

MODEL		KDS-P-02	KDS-P-04
Rated pressure range		-1000 ~ 1000 kPa	
Set pressure range		0 ~ 1000 kPa	
Withstand pressure		1200 kPa	
Fluid		Filtered air, Non-corrosive / Non-flammable gas	
Set pressure resolution	Standard mode	1 kPa	
	High resolution mode (*1)	0.1 kPa	
Power supply voltage		12 ~ 24 V DC \pm 10 %, Ripple (P-P) \leq 10 %	
Current consumption		\leq 20mA	
Switch output		1 NPN : open collector 1 output (*2) Max. Load Current : 200 mA Max. Supply Voltage : 30 V DC Residual Voltage : \leq 1.5 V	1 PNP : open collector 1 output (*2) Max. Load Current : 200 mA Max. Supply Voltage : 24 V DC Residual Voltage : \leq 1.5 V
Repeatability		\pm 0.2 % F.S. \pm 1 digit	
Hysteresis	Hysteresis Mode	1 ~ 15 digits	
	Window Comparator Mode		
Output short circuit protection		Yes	
Display		3 ½ digital, 7 segment LCD display (White) (Sampling rate : 5 times / sec.)	
Indicator accuracy	Standard mode	\pm 0.3% F.S. \pm 1 digit (ambient temperature:25 \pm 3°C)	
	High resolution mode	\pm 0.1% F.S. \pm 1 digit (ambient temperature:25 \pm 3°C)	
Switch on indicator		White Indicator 1 : OUT1	
Environment	Enclosure	IP65 (*3)	
	Ambient temp. range	Operation : 0 ~ 50 °C, Storage : -10 ~ 60 °C (No condensation or freezing)	
	Ambient humidity range	Operation / Storage : 35 ~ 85 % RH (No condensation)	
	Withstand voltage	1000V AC in 1-min (between case and lead wire)	
	Insulation resistance	\geq 50 M Ω (at 500V DC, between case and lead wire)	
	Vibration	Total amplitude 1.5 mm or 10 G, 10 Hz ~ 55 Hz ~ 10 Hz scan for 1 minute, 2 hours each direction of X, Y and Z	
	Shock	100 m/s ² (10 G), 3 times each in direction of X, Y and Z	
Temperature characteristic	Standard mode	\pm 0.5%F.S. of detected pressure (25°C) at temp. Range of 0~50°C	
	High resolution mode	\pm 5%F.S. of detected pressure (25°C) at temp. Range of 0~50°C	
Communication interface		RS485	
Port size		M5 : M5 female thread	
Lead wire		\varnothing 4 PVC - 26 AWG (0.15 mm ²) - 5 cores	
Weight (with 2 meter lead wire)		Approx. 104 g	

【NOTE :】

*1. High resolution mode is settable in differential pressure range : -199.9 kPa ~ 199.9 kPa

*2. Selectable NPN or PNP open collector circuits in setting.

*3. Dustproof protector must be installed to maintain IP65.

B ORDERING INFORMATION

K D S - P - 0 2 - M 5

Pressure Range

P : Positive (0 ~ 1000 kPa)

Output Specifications

02 : 1 NPN Output + RS485
04 : 1 PNP Output + RS485

Pressure Port

M5 : M5 female thread

Optional Parts

BT-18 : Mounting bracket
BT-19 : Mounting bracket
PA-E : Panel adapter
PA-F : Panel adapter + Front protective lid

C OUTPUT CIRCUIT WIRING DIAGRAMS

◎ NPN + RS485

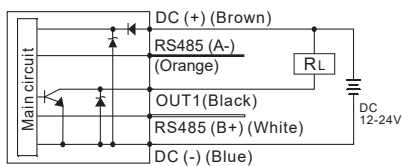

◎ PNP + RS485

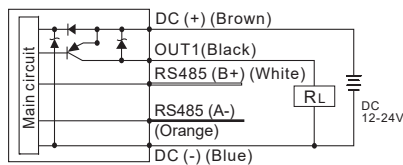

D OPERATING POINT SETTING MODE

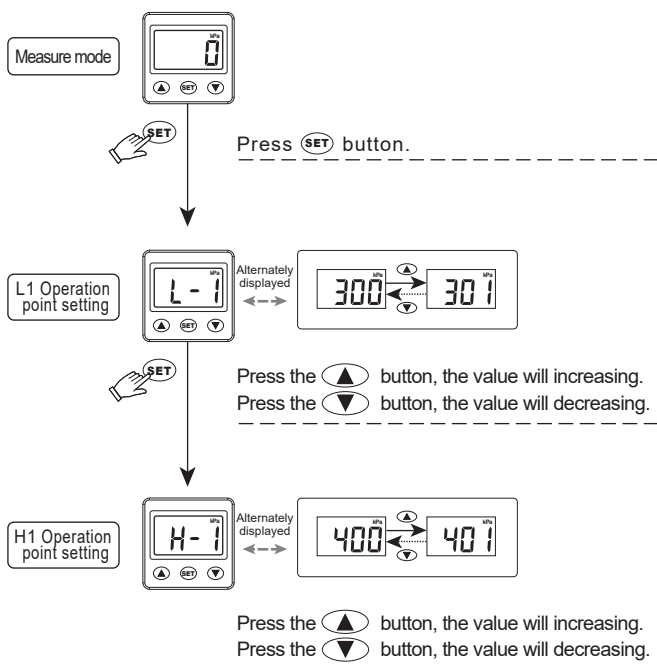

E ADVANCE SETTING MODE

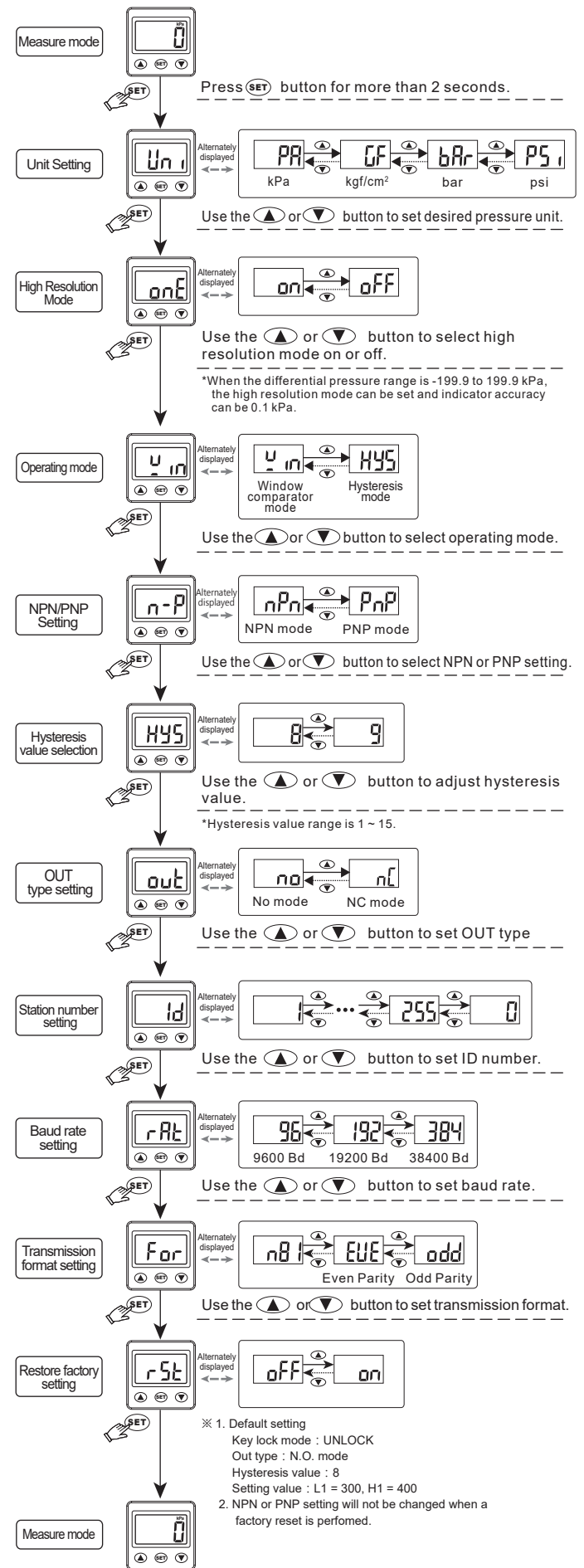

F PANEL DESCRIPTION

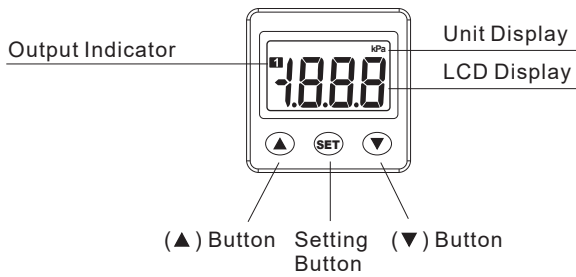

J DIMENSIONS

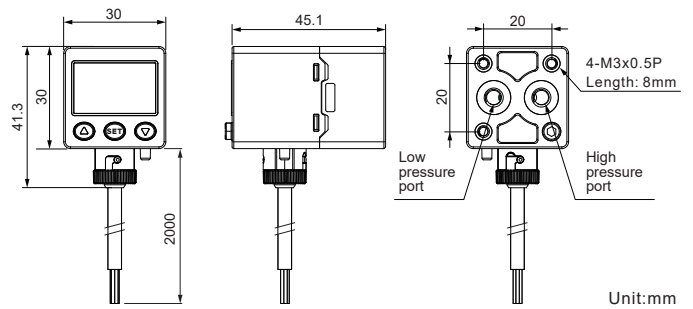

G KEY LOCK/UNLOCK MODE

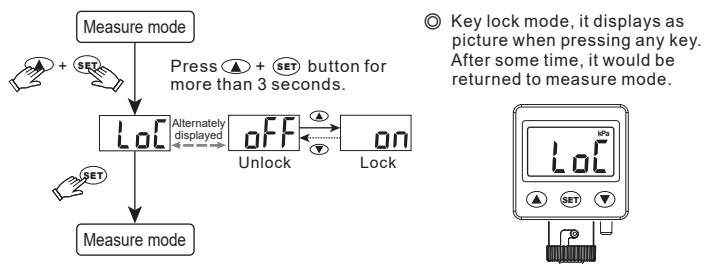

K OPTIONAL PARTS DIMENSIONS

① Mounting bracket

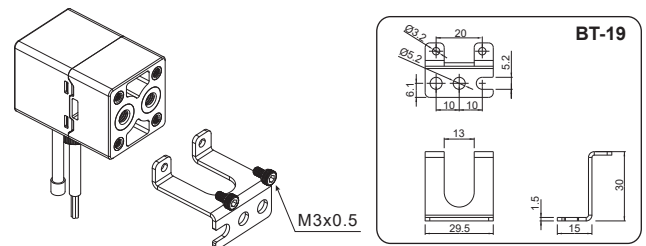
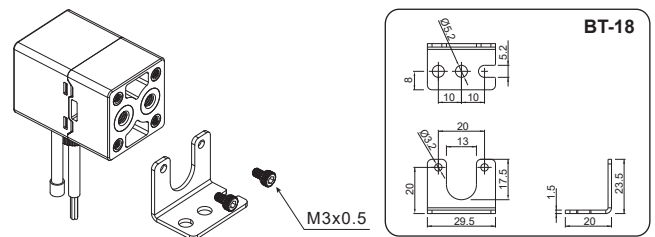

H OUTPUT TYPE

⊙ Window comparator mode

Normal open mode

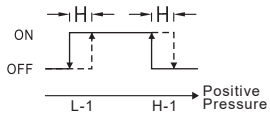

Normal close mode

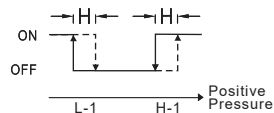

⊙ Hysteresis mode

Normal open mode

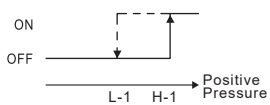

Normal close mode

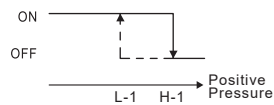

② Panel Mounting

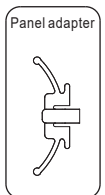
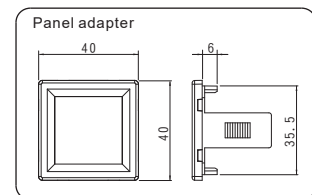
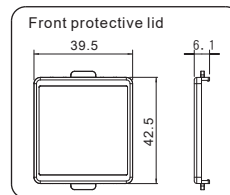
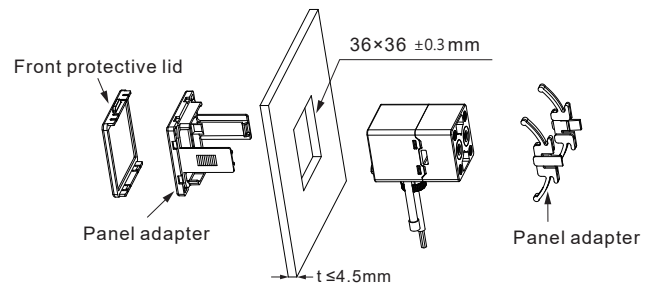

③ Accessory

Press the (▲) + (▼) button at the same time until the "0" is shown · release the button to end .

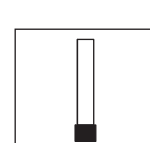
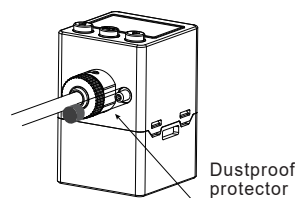
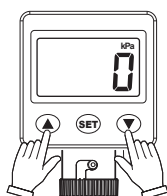

Caution :
This device must be installed to maintain IP 65 (Dust and splash proof) enclosure rating.

I ZERO POINT SETTING

L COMMUNICATION PROTOCOL (Modbus RTU)

1 Function Code

Function Code	Description	Operation
03H	Read pressure sensor data Range 1~2 data Number , 2~8 Bytes	Read
06H	Write pressure sensor data	Write

2 Example : Read pressure sensor value

Computer / PLC transmit data format (H is hexadecimal)

ID Number (01H)	Function Code (03H)	Address (0002H)	Data Number (0001H)	CRC CheckSum (25CAH)
↓				

Pressure sensor response data format

ID Number (01H)	Function Code (03H)	Data Number (02H)	Data (0001H)	CRC CheckSum (7984H)
--------------------	------------------------	----------------------	-----------------	-------------------------

3 Example : Output type setting

Computer / PLC transmit data format

ID Number (01H)	Function Code (06H)	Address (0006H)	Data (0001H)	CRC CheckSum (A80BH)
↓				

Pressure sensor response data format

ID Number (01H)	Function Code (06H)	Address (0006H)	Data (0001H)	CRC CheckSum (A80BH)
--------------------	------------------------	--------------------	-----------------	-------------------------

4 Error Code Description :

Error Code	Description
01H	Function code error
02H	Address error
03H	Illegal data or over setting value

M ERROR CODE INSTRUCTION

Error Type	Error code	Error Condition	Troubleshooting
Excess load current error	Er1	Output load current is more than 200 mA	Turn power off and check the cause of overload current or lower the current load under 200 mA, then restart.
Residual pressure error	Er3	During zero reset, ambient pressure is over ±3% F.S.	Change input pressure to ambient pressure and perform zero reset again.
Applied pressure error	HHH	Supply pressure exceeds the upper limit of pressure setting.	Adjust the pressure within operating pressure range.
	LLL	Supply pressure exceeds the lower limit of pressure setting.	
System error	Er5	Internal system error	Turn power off, and then restart. If error condition remains, please return to factory for inspection.

N PRESSURE UNIT CONVERSION TABLE

From \ To	Pa	kPa	MPa	kgf/cm ²	mmHg	psi	bar	inHg
1 Pa	1	0.001	0.000001	0.000010197	0.00750062	0.000145038	0.00001	0.0002953
1 kPa	1000	1	0.001	0.010197	7.500616	0.145038	0.01	0.2953
1 MPa	1000000	1000	1	10.197	7500.616	145.038	10	295.2998
1 kgf/cm ²	98066.5	98.0665	0.0980665	1	735.559	14.2233	0.980665	28.95979
1 mmHg	133.32	0.13332	0.001333	0.0013595	1	0.019336	0.0013332	0.039370
1 psi	6895	6.895	0.006895	0.07031	51.7157	1	0.06895	2.036074
1 bar	100000	100	0.1	1.01972	750.062	14.5038	1	29.52998
1 inHg	3386.388	3.386388	0.003386	0.034530	25.4	0.491141	0.033863	1

5 Modbus RTU Mode Protocol Address Map :

Modbus	Address	Item	Description	Operation
40001	0000H	ID Number setting	0H ~ FFH (0 ~ 255)	Read Write
40002	0001H	Switch state	0 : OFF 1 : ON	Read
40003	0002H	Pressure value	Read pressure value -3E8H~3E8H Pressure rang : -1000~1000 kPa	Read
		High resolution mode Pressure value	Read pressure value -7CFH~7CFH Pressure rang : -199.9~199.9 kPa	Read
40004	0003H	Pressure unit	0 : kPa 1 : kgf 2 : bar 3 : psi	Read Write
40005	0004H	Decimal place	0 : None 1 : One decimal place 0.1 2 : Two decimal places 0.01 3 : Three decimal places 0.001	Read
40007	0006H	Output type	0 : NO 1 : NC	Read Write
40010	0009H	Hysteresis value	Read hysteresis value 1H ~ FH (Range : 1 ~ 15)	Read Write
40011	000AH	L1 setting value	0 : Read setting value (Default : 300 kPa) 1 : Write setting value	Read Write
		High resolution mode L1 setting value	0 : Read setting value (Default : 30.0 kPa) 1 : Write setting value	Read Write
40012	000BH	H1 setting value	0 : Read setting value (Default : 400 kPa) 1 : Write setting value	Read Write
		High resolution mode H1 setting value	0 : Read setting value (Default : 40.0 kPa) 1 : Write setting value	Read Write
40013	000CH	Baud rate setting	0 : 9600 bps 1 : 19200 bps 2 : 38400 bps	Read Write
40014	000DH	Transmission format setting	0 : N81 1 : E81 2 : O81	Read Write
40016	000FH	Reset to the default setting	0 : Read default setting 1 : Write default setting (*2)	Write
40020	0013H	Key lock function	0 : UNLOCK 1 : LOCK	Read Write
40021	0014H	Switch type	0 : NPN 1 : PNP	Read Write
40023	0016H	Zero reset	0 : None return to zero 1 : Zero reset (*1)	Write
40050	0031H	High resolution mode	0 : OFF 1 : ON	Read Write
40054	0035H	Error Code	bit0 : Output load current is more than 200 mA. bit1 : Supply pressure exceeds the upper limit of pressure setting. bit2 : Supply pressure exceeds the lower limit of pressure setting. bit3 : Hysteresis value exceeds the range. bit4 : L1 setting value error bit5 : H1 setting value error bit6 : Zero reset error (*1) bit7 : EEPROM R/W error	Read

*1: Zero reset which pressure range exceeds ±3% F.S, then error code display 03H and function code 0035H bit6 is 1.

*2: Default setting

Key lock function : UNLOCK ; Out type : N.O. mode ; Hysteresis value : 8
Setting value : L1 = 300, H1 = 400